

M12 Connectors

Series W

Robust and Reliable Circular Connectors



Hyperboloid Technology

Smiths Interconnect offers an extensive range of superior contact technologies suitable for standard and custom solutions. Hypertac® (HYPERboloid conTACT) is the original superior performing hyperboloid contact technology designed for use in all applications and in harsh and demanding environments where high reliability and safety are critical. The inherent electrical and mechanical characteristics of the Hypertac hyperboloid contact ensures unrivalled performance in terms of reliability, number of mating cycles, low contact force and minimal contact resistance. The shape of the contact sleeve is formed by hyperbolically arranged contact wires, which align themselves elastically as contact lines around the pin, providing a number of linear contact paths.

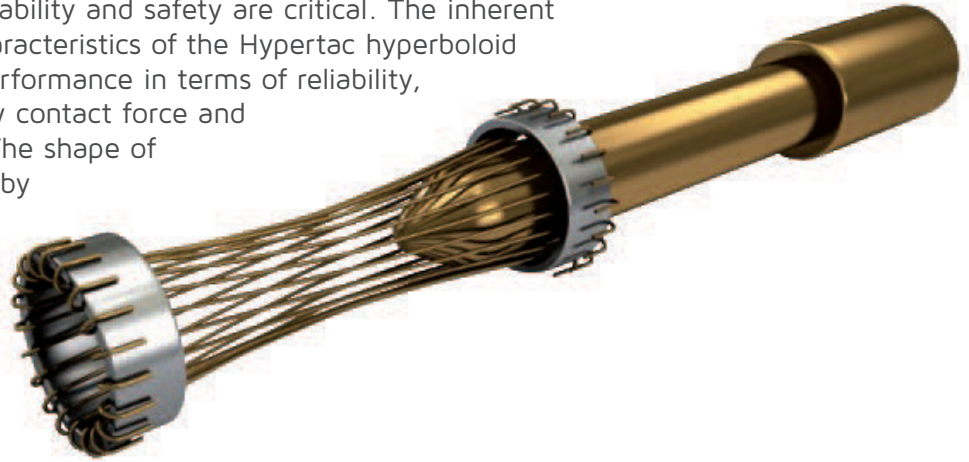

Features	Benefits
<p>Low insertion/extraction forces</p> <p>The angle of the socket wires allows tight control of the pin insertion and extraction forces. The spring wires are smoothly deflected to make line contact with the pin.</p>	<p>High density interconnect systems</p> <p>Significant reductions in size and weight of sub-system designs. No additional hardware is required to overcome mating and un-mating forces.</p>
<p>Long contact life</p> <p>The smooth and light wiping action minimizes wear on the contact surfaces. Contacts perform up to 100,000 insertion/extraction cycles with minimal degradation in performance.</p>	<p>Low cost of ownership</p> <p>The Hypertac contact technology will surpass most product requirements, thus eliminating the burden and cost of having to replace the connector or the entire subsystem.</p>
<p>Lower contact resistance</p> <p>The design provides a far greater contact area and the wiping action of the wires insures a clean and polished contact surface. Our contact technology has about half the resistance of conventional contact designs.</p>	<p>Low power consumption</p> <p>The lower contact resistance of our technology results in a lower voltage drop across the connector reducing the power consumption and heat generation within the system.</p>
<p>Higher current ratings</p> <p>The design parameters of the contact (e.g., the number, diameter and angle of the wires) may be modified for any requirement. The number of wires can be increased so the contact area is distributed over a larger surface. Thus, the high current carried by each wire because of its intimate line contact, can be multiplied many times.</p>	<p>Maximum contact performance</p> <p>The lower contact resistance of the Hypertac contact reduces heat build-up; therefore Hypertac contacts are able to handle far greater current in smaller contact assemblies without the detrimental effects of high temperature.</p>
<p>Immunity to shock & vibration</p> <p>The low mass and resultant low inertia of the wires enable them to follow the most abrupt or extreme excursions of the pin without loss of contact. The contact area extends 360° around the pin and is uniform over its entire length. The 3 dimensional symmetry of the Hypertac contact design guarantees electrical continuity in all circumstances.</p>	<p>Reliability under harsh environments</p> <p>Harsh environmental conditions require connectors that will sustain their electrical integrity even under the most demanding conditions such as shock and vibration. The Hypertac contact provides unmatched stability in demanding environments when failure is not an option.</p>

Contents

M12 Series W	2
Technical characteristics	2
How to order	3
Connector design:	
Female cable plugs	6
Male cable plugs	10
Straight male receptacles	14
Angled male receptacle	17
Female panel feed through	18
Contacts:	
Hypertac® hyperboloid contacts	24
HCS™ stamped hyperboloid contacts	25
Tools	26
Additional services and accessoires	27
Assembly instructions	28

M12 Series W

Robust and Reliable Connector System



The Smiths Interconnect M12 series is a robust and compact connectivity solution that has been developed to address specific application environments where space and weight are key concerns. The M12's compact and robust design incorporates the industry-leading Hypertac® hyperboloid contacts that deliver unrivalled performance, ease of use and unparalleled reliability. In real-world industrial operating scenarios, the M12's comprehensive sealing properties deliver a competitive edge by ensuring uninterrupted signal integrity through keeping out dust, moisture, dirt and oil that can corrupt the connection.

The design features a unique side loading contact retention system that provides a positive contact retention and simplifies the assembly process. This simplified approach to contact assembly not only makes the product series very user friendly, but also reduces assembly times. Within a common housing design, the M12 series includes insert options from 3 to 8 ways, with both crimp and solder contact terminations available.

Smiths Interconnect M12 connectors, are ideal for communication applications, including Gigabit internet network on-board, factory automation, drive motors, machine tools, robots, conveyor systems, handling machines and elevators, etc. They all feature outstanding protection against electromagnetic interference through a full 360° screen connection.

A complete range of options and accessories are available as standard, making the series suitable for a wide range of applications. In addition, the total number of components used in the design has been optimized to reduce stocking requirements.

M12 connector system that resists high levels of shock & vibration

Features & Benefits

Hyperboloid Contact System

- Reduced cost of ownership through unrivalled contact performance and reliability
- Machined and stamped hyperboloid contact options
- Floating contacts
- Contacts can be crimped automatically

Superior Design

- 360° EMC shielded connection, protecting against electromechanical interference
- Versatile cable clamp which accommodates cable with shielding braid up to Ø 10mm

Easy of Assembly and Use

- Aesthetically pleasing and compact design
- Typically saves 10% more space than common connectors
- Minimized number of components, simplified assembly and reduced stocking requirements

Enhanced Functionality

- Developing time savings through improved production yields
- Side loading contact retention
- Simplified assembly, high contact retention forces
- Vibration protected

Technical Characteristics

Mechanical

Contact diameter 2, 3, 4, 5poles	Ø 1mm	DIN EN 61076-2-101
Contact diameter 8poles	Ø 0.8mm	DIN EN 61076-2-101
Coding	A-code, D-code	
Mating cycles	>500	
Contact retention force	>20N	EN 61984

Electrical

Current rating	4 A (2...5 contacts) 2 A (6...8 contacts)	
Voltage rating	90 V (5 poles A-code) 250 V 60 V 30 V	NF F 61-030 DIN 61 076-2-101 (4 contacts) DIN 61 076-2-101 (5 contacts) DIN 61 076-2-101 (8 contacts)
Withstanding voltage	2500 V	EN 50124-1
Contact resistance	<7 mΩ	
Insulation resistance	≤9 x 10 ³ MΩ	
Overvoltage category	III	EN 61984

Material & Finishes

Shell	Brass, zinc-diecast	
Machined contacts	CuZn alloy	
Stamped contacts	Tin-bronze, stainless steel	
Insert	PA66, PA6	
Sealing	FPM	
Shell plating	Nickel	
Machined contacts plating	Nickel and gold	
Stamped contacts plating	Partly gold plated	

Physical & Environmental

Operating temperature range	-40°C ... 125°C	
Environmental level	IP67	
Contamination level	3 PD3A	DIN 60664-1 EN 50124-1
Installation altitude	2000 m (2 – 5poles) 6000 m (8poles)	EN 61984
Fluid resistance	Oil, hydrolysis, microbes	
Salt spray	500h	
Fire & Smoke	VO	UL 94
RoHS	Compliant	

How To Order



W

1



2



3



4



5



6



7

1 Connector Family	W	M12 Circular Connectors, Series W [Fixed]		
2 Connector Design	PC	Straight female cable plug	EA	Straight male receptacle, front panel mounting M16x1.5
	PJ	Straight female cable plug with flange	EB	Straight male receptacle, rear panel mounting M16x1.5
	PE	Angled female cable plug	EC	Angled male receptacle, rotatable back-shell
	PL	Right angle female cable plug, rotatable backshell	ED	Straight male receptacle, front panel mounting M12x1
	RC	Straight male cable plug	DA	Panel feed through, female, hexagon wrench size 17, front panel mounting M16x1.5
	RJ	Straight male cable plug with flange	DB	Panel feed through, female, rear panel mounting M16x1.5
	RE	Angled male cable plug	DC	Panel feed through, female, front panel mounting M16x1.5
	RL	Right angle male cable plug, rotatable backshell	DD	Panel feed through, female, rear panel mounting M16x1.5 with grounding pin
			DE	Panel feed through, female, front panel mounting M12x1
3 Plating	A	nickel plated		
4 Inserts	04A	4way D-coded for sockets, clockwise polarized, for straight female cable plugs	05C	5way A-coded for sockets, clockwise polarized, for panel feed through and 90° female cable plugs
	04B	4way D-coded for pins, counterclockwise polarized, for straight male cable plugs	05D	5way A-coded for pins, counterclockwise polarized, for receptacles and 90° male cable plugs
	04C	4way D-coded for sockets, clockwise polarized, for panel feed through and 90° female cable plugs	08A	8way A-coded for sockets, clockwise polarized, for straight female cable plugs
	04D	4way D-coded for pins, counterclockwise polarized, for receptacles and 90° male cable plugs	08B	8way A-coded for pins, counterclockwise polarized, for straight male cable plugs
	05A	5way A-coded for sockets, clockwise polarized, for straight female cable plugs	08C	8way A-coded for sockets, clockwise polarized, for panel feed through and 90° female cable plugs
	05B	5way A-coded for pins, counterclockwise polarized, for straight male cable plugs	08D	8way A-coded for pins, counterclockwise polarized, for receptacles and 90° male cable plugs

How To Order



W

1



2



3



4



5



6



7

5 Termination Style	N N N N without contacts (machined or stamped contacts to be ordered separately)	
	F R A N F R B N including Hypertac® hyperboloid sockets Ø 1mm, mandrel crimp barrel	M R A N M R B N including machined pins Ø 1mm, mandrel crimp barrel
	F D A N F D B N including Hypertac® hyperboloid sockets Ø 1mm with solder pin	M D A N M D B N including machined pins Ø 1mm with solder pin
	F R C N F R D N including Hypertac® hyperboloid sockets Ø 0.8mm, mandrel crimp barrel	M R C N M R D N including machined pins Ø 0.8mm, mandrel crimp barrel
	F D E N including Hypertac® hyperboloid sockets Ø 1mm, dip solder for PCB assembly, 90° bent contacts	
6 Cable Clamping	0 0 0 without cable clamp for receptacles and panel feed through	2 9 4 Cable clamp for plugs, cable diameter size Ø 6 - 8 mm
	2 8 3 Cable clamp for plugs, cable diameter size Ø 9 - 10 mm	2 9 3 Cable clamp for plugs, cable diameter size Ø 4.5 - 6 mm
	3 0 8 Cable clamp for plugs, cable diameter size Ø 7.5 - 9 mm	
7 Version Number	0 2 5way insulator partially equipped for 2pole version	0 6 8way insulator partially equipped for 6pole version
	0 3 5way insulator partially equipped for 3pole version	0 7 8way insulator partially equipped for 7pole version
	0 4 5way insulator partially equipped for 4pole version	

Female Cable Plugs

Straight female cable plug - Type PC

Straight female cable plug with coupling ring, shieldable, variable cable clamps

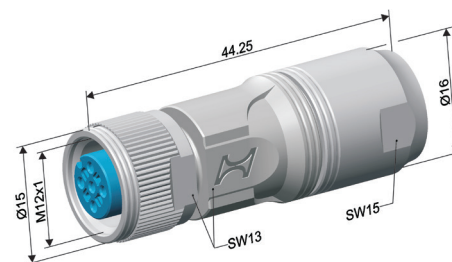

Without Contacts (for ordering Ø 1mm Hypertac® or stamped hyperboloid sockets separately)

Insert	Type	Part Number	Contacts
<p>D-Cod.</p>	4way D-coded	W PC A 04A NNNN 283 (cable diameter size 9 to 10mm) W PC A 04A NNNN 294 (cable diameter size 6 to 8mm) W PC A 04A NNNN 293 (cable diameter size 4.5 to 6mm) W PC A 04A NNNN 308 (cable diameter size 7.5 to 9mm)	without contacts
<p>A-Cod.</p>	5way A-coded	W PC A 05A NNNN 283 (cable diameter size Ø 9 - 10mm) W PC A 05A NNNN 294 (cable diameter size Ø 6 - 8mm) W PC A 05A NNNN 293 (cable diameter size Ø 4.5 - 6mm) W PC A 04A NNNN 308 (cable diameter size Ø 7.5 - 9mm)	without contacts

Ø 1mm Hypertac® hyperboloid sockets (AWG 24-18)

Insert	Type	Part Number ¹	Contacts
<p>D-Cod.</p>	4way D-coded	W PC A 04A FRAN 283 .. (cable diameter size Ø 9 - 10mm) W PC A 04A FRAN 294 .. (cable diameter size Ø 6 - 8mm) W PC A 04A FRAN 293 .. (cable diameter size Ø 4.5 - 6mm) W PC A 04A FRAN 308 .. (cable diameter size Ø 7.5 - 9mm)	
<p>A-Cod.</p>	5way A-coded	W PC A 05A FRAN 283 .. (cable diameter size Ø 9 - 10mm) W PC A 05A FRAN 294 .. (cable diameter size Ø 6 - 8mm) W PC A 05A FRAN 293 .. (cable diameter size Ø 4.5 - 6mm) W PC A 05A FRAN 308 .. (cable diameter size Ø 7.5 - 9mm)	

Without Contacts (for ordering Ø 0.8mm Hypertac® or stamped hyperboloid sockets separately)

Insert	Type	Part Number	Contacts
<p>A-Cod.</p>	8way A-coded	W PC A 08A NNNN 283 (cable diameter size Ø 9 - 10mm) W PC A 08A NNNN 294 (cable diameter size Ø 6 - 8mm) W PC A 08A NNNN 293 (cable diameter size Ø 4.5 - 6mm) W PC A 08A NNNN 308 (cable diameter size Ø 7.5 - 9mm)	without contacts

Ø 0.8mm Hypertac® hyperboloid sockets (AWG 24-20)

Insert	Type	Part Number	Contacts
<p>A-Cod.</p>	8way A-coded	W PC A 08A FRCN 283 (cable diameter size Ø 9 - 10mm) W PC A 08A FRCN 294 (cable diameter size Ø 6 - 8mm) W PC A 08A FRCN 293 (cable diameter size Ø 4.5 - 6mm) W PC A 08A FRCN 308 (cable diameter size Ø 7.5 - 9mm)	

Ø 0.8mm Hypertac® hyperboloid sockets (AWG 30-22)

Insert	Type	Part Number	Contacts
<p>A-Cod.</p>	8way A-coded	W PC A 08A FRDN 283 (cable diameter size Ø 9 - 10mm) W PC A 08A FRDN 294 (cable diameter size Ø 6 - 8mm) W PC A 08A FRDN 293 (cable diameter size Ø 4.5 - 6mm) W PC A 08A FRDN 308 (cable diameter size Ø 7.5 - 9mm)	

Female Cable Plugs

Straight female cable plug - Type PJ

Straight female cable plug with external thread, flange mounting, shieldable, variable cable clamps

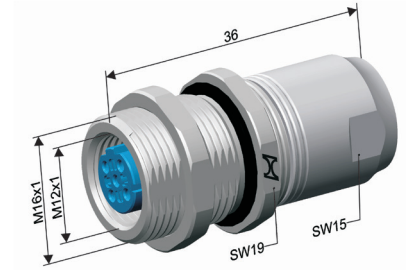

Without Contacts (for ordering \varnothing 1mm Hypertac® or stamped hyperboloid sockets separately)

Insert	Type	Part Number	Contacts
<p>D-Cod.</p>	4way D-coded	W PJ A 04A NNNN 283 (cable diameter size \varnothing 9 - 10mm) W PJ A 04A NNNN 294 (cable diameter size \varnothing 6 - 8mm) W PJ A 04A NNNN 293 (cable diameter size \varnothing 4.5 - 6mm) W PJ A 04A NNNN 308 (cable diameter size \varnothing 7.5 - 9mm)	without contacts
<p>A-Cod.</p>	5way A-coded	W PJ A 05A NNNN 283 (cable diameter size \varnothing 9 - 10mm) W PJ A 05A NNNN 294 (cable diameter size \varnothing 6 - 8mm) W PJ A 05A NNNN 293 (cable diameter size \varnothing 4.5 - 6mm) W PJ A 05A NNNN 308 (cable diameter size \varnothing 7.5 - 9mm)	without contacts

\varnothing 1mm Hypertac® hyperboloid sockets (AWG 24-18)

Insert	Type	Part Number ¹	Contacts
<p>D-Cod.</p>	4way D-coded	W PJ A 04A FRAN 283 .. (cable diameter size \varnothing 9 - 10mm) W PJ A 04A FRAN 294 .. (cable diameter size \varnothing 6 - 8mm) W PJ A 04A FRAN 293 .. (cable diameter size \varnothing 4.5 - 6mm) W PJ A 04A FRAN 308 .. (cable diameter size \varnothing 7.5 - 9mm)	
<p>A-Cod.</p>	5way A-coded	W PJ A 05A FRAN 283 .. (cable diameter size \varnothing 9 - 10mm) W PJ A 05A FRAN 294 .. (cable diameter size \varnothing 6 - 8mm) W PJ A 05A FRAN 293 .. (cable diameter size \varnothing 4.5 - 6mm) W PJ A 05A FRAN 308 .. (cable diameter size \varnothing 7.5 - 9mm)	

Without Contacts (for ordering \varnothing 0.8mm Hypertac® or stamped hyperboloid sockets separately)

Insert	Type	Part Number	Contacts
<p>A-Cod.</p>	8way A-coded	W PJ A 08A NNNN 283 (cable diameter size \varnothing 9 - 10mm) W PJ A 08A NNNN 294 (cable diameter size \varnothing 6 - 8mm) W PJ A 08A NNNN 293 (cable diameter size \varnothing 4.5 - 6mm) W PJ A 08A NNNN 308 (cable diameter size \varnothing 7.5 - 9mm)	without contacts

\varnothing 0.8mm Hypertac® hyperboloid sockets (AWG 24-20)

Insert	Type	Part Number	Contacts
<p>A-Cod.</p>	8way A-coded	W PJ A 08A FRCN 283 (cable diameter size \varnothing 9 - 10mm) W PJ A 08A FRCN 294 (cable diameter size \varnothing 6 - 8mm) W PJ A 08A FRCN 293 (cable diameter size \varnothing 4.5 - 6mm) W PJ A 08A FRCN 308 (cable diameter size \varnothing 7.5 - 9mm)	

\varnothing 0.8mm Hypertac® hyperboloid sockets (AWG 30-22)

Insert	Type	Part Number	Contacts
<p>A-Cod.</p>	8way A-coded	W PJ A 08A FRDN 283 (cable diameter size \varnothing 9 - 10mm) W PJ A 08A FRDN 294 (cable diameter size \varnothing 6 - 8mm) W PJ A 08A FRDN 293 (cable diameter size \varnothing 4.5 - 6mm) W PJ A 08A FRDN 308 (cable diameter size \varnothing 7.5 - 9mm)	

Female Cable Plugs

Angled female cable plug - Type PE

90° female cable plug with coupling ring, shieldable, variable cable clamps

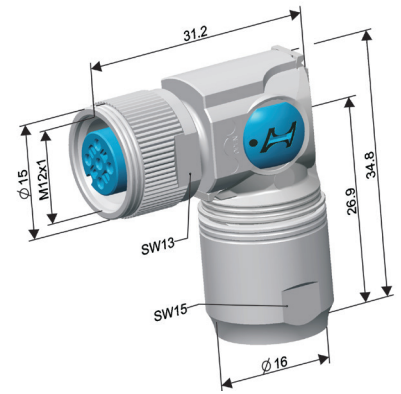

Without Contacts (for ordering Ø 1mm Hypertac® or stamped hyperboloid sockets separately)

Insert	Type	Part Number	Contacts
<p>D-Cod. 1 2 3 4</p>	4way D-coded	W PE A 04C NNNN 283 (cable diameter size Ø 9 - 10mm) W PE A 04C NNNN 294 (cable diameter size Ø 6 - 8mm) W PE A 04C NNNN 293 (cable diameter size Ø 4.5 - 6mm) W PE A 04C NNNN 308 (cable diameter size Ø 7.5 - 9mm)	without contacts
<p>A-Cod. 5 1 2 3 4</p>	5way A-coded	W PE A 05C NNNN 283 (cable diameter size Ø 9 - 10mm) W PE A 05C NNNN 294 (cable diameter size Ø 6 - 8mm) W PE A 05C NNNN 293 (cable diameter size Ø 4.5 - 6mm) W PE A 05C NNNN 308 (cable diameter size Ø 7.5 - 9mm)	without contacts

Ø 1mm Hypertac® hyperboloid sockets (AWG 24-18)

Insert	Type	Part Number ¹	Contacts
<p>D-Cod. 1 2 3 4</p>	4way D-coded	W PE A 04C FRAN 283 .. (cable diameter size Ø 9 - 10mm) W PE A 04C FRAN 294 .. (cable diameter size Ø 6 - 8mm) W PE A 04C FRAN 293 .. (cable diameter size Ø 4.5 - 6mm) W PE A 04C FRAN 308 .. (cable diameter size Ø 7.5 - 9mm)	
<p>A-Cod. 5 1 2 3 4</p>	5way A-coded	W PE A 05C FRAN 283 .. (cable diameter size Ø 9 - 10mm) W PE A 05C FRAN 294 .. (cable diameter size Ø 6 - 8mm) W PE A 05C FRAN 293 .. (cable diameter size Ø 4.5 - 6mm) W PE A 05C FRAN 308 .. (cable diameter size Ø 7.5 - 9mm)	

Without Contacts (for ordering Ø 0.8mm Hypertac® or stamped hyperboloid sockets separately)

Insert	Type	Part Number	Contacts
<p>A-Cod. 8 1 2 3 4 5 6 7</p>	8way A-coded	W PE A 08C NNNN 283 (cable diameter size Ø 9 - 10mm) W PE A 08C NNNN 294 (cable diameter size Ø 6 - 8mm) W PE A 08C NNNN 293 (cable diameter size Ø 4.5 - 6mm) W PE A 08C NNNN 308 (cable diameter size Ø 7.5 - 9mm)	without contacts

Ø 0.8mm Hypertac® hyperboloid sockets (AWG 24-20)

Insert	Type	Part Number	Contacts
<p>A-Cod. 8 1 2 3 4 5 6 7</p>	8way A-coded	W PE A 08C FRCN 283 (cable diameter size Ø 9 - 10mm) W PE A 08C FRCN 294 (cable diameter size Ø 6 - 8mm) W PE A 08C FRCN 293 (cable diameter size Ø 4.5 - 6mm) W PE A 08C FRCN 308 (cable diameter size Ø 7.5 - 9mm)	

Ø 0.8mm Hypertac® hyperboloid sockets (AWG 30-22)

Insert	Type	Part Number	Contacts
<p>A-Cod. 8 1 2 3 4 5 6 7</p>	8way A-coded	W PE A 08C FRDN 283 (cable diameter size Ø 9 - 10mm) W PE A 08C FRDN 294 (cable diameter size Ø 6 - 8mm) W PE A 08C FRDN 293 (cable diameter size Ø 4.5 - 6mm) W PE A 08C FRDN 308 (cable diameter size Ø 7.5 - 9mm)	

Female Cable Plugs

Angled female cable plug, rotatable backshell - Type PL

90° angled female cable plug with coupling ring, shieldable, variable cable clamps, rotatable backshell. Rotatable connector backshell offers customer-configurable cable outlet direction. The outlet directions can be adjusted in 12 steps of 30° to a maximum angle of 330°.

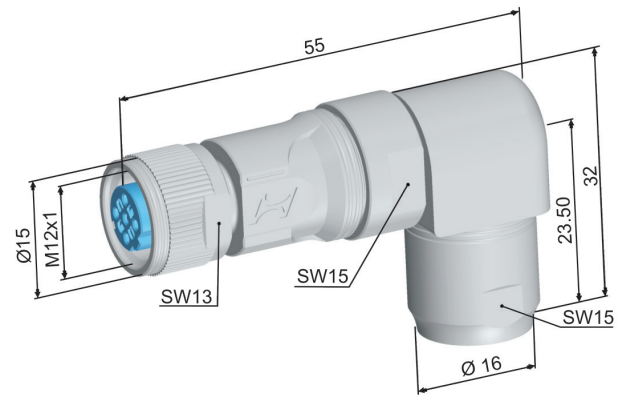

Without Contacts (for ordering Ø 1 mm Hypertac® sockets separately)

Insert	Type	Part Number	Contacts
<p>D-Cod.</p>	4way D-coded	W PL A 04A NNNN 283 (cable diameter size 9 to 10mm) W PL A 04A NNNN 294 (cable diameter size 6 to 8mm) W PL A 04A NNNN 293 (cable diameter size 4.5 to 6mm) W PL A 04A NNNN 308 (cable diameter size 7.5 to 9mm)	without contacts
<p>A-Cod.</p>	5way A-coded	W PL A 05A NNNN 283 (cable diameter size Ø 9 - 10mm) W PL A 05A NNNN 294 (cable diameter size Ø 6 - 8mm) W PL A 05A NNNN 293 (cable diameter size Ø 4.5 - 6mm) W PL A 04A NNNN 308 (cable diameter size Ø 7.5 - 9mm)	without contacts

Ø 1mm Hypertac® hyperboloid sockets (AWG 24-18)

Insert	Type	Part Number ¹	Contacts
<p>D-Cod.</p>	4way D-coded	W PL A 04A FRAN 283 .. (cable diameter size Ø 9 - 10mm) W PL A 04A FRAN 294 .. (cable diameter size Ø 6 - 8mm) W PL A 04A FRAN 293 .. (cable diameter size Ø 4.5 - 6mm) W PL A 04A FRAN 308 .. (cable diameter size Ø 7.5 - 9mm)	
<p>A-Cod.</p>	5way A-coded	W PL A 05A FRAN 283 .. (cable diameter size Ø 9 - 10mm) W PL A 05A FRAN 294 .. (cable diameter size Ø 6 - 8mm) W PL A 05A FRAN 293 .. (cable diameter size Ø 4.5 - 6mm) W PL A 05A FRAN 308 .. (cable diameter size Ø 7.5 - 9mm)	

Without Contacts (for ordering Ø 0.8mm Hypertac® or stamped hyperboloid sockets separately)

Insert	Type	Part Number	Contacts
<p>A-Cod.</p>	8way A-coded	W PL A 08A NNNN 283 (cable diameter size Ø 9 - 10mm) W PL A 08A NNNN 294 (cable diameter size Ø 6 - 8mm) W PL A 08A NNNN 293 (cable diameter size Ø 4.5 - 6mm) W PL A 08A NNNN 308 (cable diameter size Ø 7.5 - 9mm)	without contacts

Ø 0.8mm Hypertac® hyperboloid sockets (AWG 24-20)

Insert	Type	Part Number	Contacts
<p>A-Cod.</p>	8way A-coded	W PL A 08A FRCN 283 (cable diameter size Ø 9 - 10mm) W PL A 08A FRCN 294 (cable diameter size Ø 6 - 8mm) W PL A 08A FRCN 293 (cable diameter size Ø 4.5 - 6mm) W PL A 08A FRCN 308 (cable diameter size Ø 7.5 - 9mm)	

Ø 0.8mm Hypertac® hyperboloid sockets (AWG 30-22)

Insert	Type	Part Number	Contacts
<p>A-Cod.</p>	8way A-coded	W PL A 08A FRDN 283 (cable diameter size Ø 9 - 10mm) W PL A 08A FRDN 294 (cable diameter size Ø 6 - 8mm) W PL A 08A FRDN 293 (cable diameter size Ø 4.5 - 6mm) W PL A 08A FRDN 308 (cable diameter size Ø 7.5 - 9mm)	

Male Cable Plugs

Straight male cable plug - Type RC

Straight male cable plug with external thread, shieldable, variable cable clamps

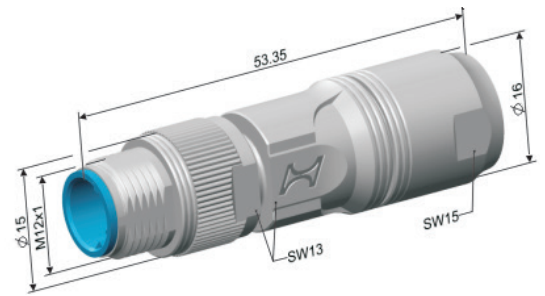

Without Contacts (for ordering Ø 1mm machined or stamped pins separately)

Insert	Type	Part Number	Contacts
<p>D-Cod.</p>	4way D-coded	W RC A 04B NNNN 283 (cable diameter size Ø 9 - 10mm) W RC A 04B NNNN 294 (cable diameter size Ø 6 - 8mm) W RC A 04B NNNN 293 (cable diameter size Ø 4.5 - 6mm) W RC A 04B NNNN 308 (cable diameter size Ø 7.5 - 9mm)	without contacts
<p>A-Cod.</p>	5way A-coded	W RC A 05B NNNN 283 (cable diameter size Ø 9 - 10mm) W RC A 05B NNNN 294 (cable diameter size Ø 6 - 8mm) W RC A 05B NNNN 293 (cable diameter size Ø 4.5 - 6mm) W RC A 05B NNNN 308 (cable diameter size Ø 7.5 - 9mm)	without contacts

Ø 1mm machined pins (AWG 24-18)

Insert	Type	Part Number ¹	Contacts
<p>D-Cod.</p>	4way D-coded	W RC A 04B MRAN 283 .. (cable diameter size Ø 9 - 10mm) W RC A 04B MRAN 294 .. (cable diameter size Ø 6 - 8mm) W RC A 04B MRAN 293 .. (cable diameter size Ø 4.5 - 6mm) W RC A 04B MRAN 308 .. (cable diameter size Ø 7.5 - 9mm)	
<p>A-Cod.</p>	5way A-coded	W RC A 05B MRAN 283 .. (cable diameter size Ø 9 - 10mm) W RC A 05B MRAN 294 .. (cable diameter size Ø 6 - 8mm) W RC A 05B MRAN 293 .. (cable diameter size Ø 4.5 - 6mm) W RC A 05B MRAN 308 .. (cable diameter size Ø 7.5 - 9mm)	

Without Contacts (for ordering Ø 0.8mm machined or stamped pins separately)

Insert	Type	Part Number	Contacts
<p>A-Cod.</p>	8way A-coded	W RC A 08B NNNN 283 (cable diameter size Ø 9 - 10mm) W RC A 08B NNNN 294 (cable diameter size Ø 6 - 8mm) W RC A 08B NNNN 293 (cable diameter size Ø 4.5 - 6mm) W RC A 08B NNNN 308 (cable diameter size Ø 7.5 - 9mm)	without contacts

Ø 0.8mm machined pins (AWG 24-20)

Insert	Type	Part Number	Contacts
<p>A-Cod.</p>	8way A-coded	W RC A 08B MRCN 283 (cable diameter size Ø 9 - 10mm) W RC A 08B MRCN 294 (cable diameter size Ø 6 - 8mm) W RC A 08B MRCN 293 (cable diameter size Ø 4.5 - 6mm) W RC A 08B MRCN 308 (cable diameter size Ø 7.5 - 9mm)	

Ø 0.8mm machined pins (AWG 30-22)

Insert	Type	Part Number	Contacts
<p>A-Cod.</p>	8way A-coded	W RC A 08B MRDN 283 (cable diameter size Ø 9 - 10mm) W RC A 08B MRDN 294 (cable diameter size Ø 6 - 8mm) W RC A 08B MRDN 293 (cable diameter size Ø 4.5 - 6mm) W RC A 08B MRDN 308 (cable diameter size Ø 7.5 - 9mm)	

Male Cable Plugs

Straight male cable plug - Type RJ

Straight male cable plug with external thread, flange mounting, shieldable, variable cable clamps

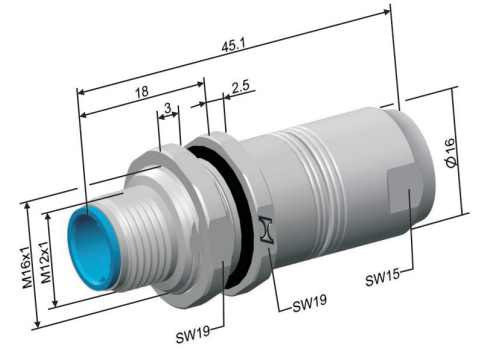

Without Contacts (for ordering Ø 1 mm machined or stamped pins separately)

Insert	Type	Part Number	Contacts
	4way D-coded	W RJ A 04B NNNN 283 00 A1(cable diameter size 9 to 10mm)	without contacts

Ø 1 mm machined Pins (AWG 24-18)

Insert	Type	Part Number	Contacts
	4way D-coded	W RJ A 04B MRAN 283 (cable diameter size 9 to 10mm) W RJ A 04B MRAN 294 (cable diameter size 4.5 to 6mm)	

Male Cable Plugs

Angled male cable plug - Type RE

90° male cable plug with external thread, shieldable, variable cable clamps

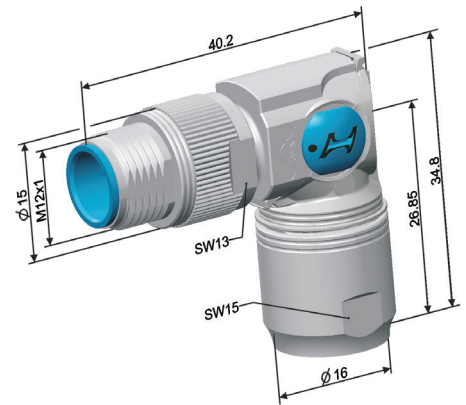

Without Contacts (for ordering Ø 1mm machined or stamped pins separately)

Insert	Type	Part Number	Contacts
<p>D-Cod.</p>	4way D-coded	W RE A 04D NNNN 283 (cable diameter size Ø 9 - 10mm) W RE A 04D NNNN 294 (cable diameter size Ø 6 - 8mm) W RE A 04D NNNN 293 (cable diameter size Ø 4.5 - 6mm) W RE A 04D NNNN 308 (cable diameter size Ø 7.5 - 9mm)	without contacts
<p>A-Cod.</p>	5way A-coded	W RE A 05D NNNN 283 (cable diameter size Ø 9 - 10mm) W RE A 05D NNNN 294 (cable diameter size Ø 6 - 8mm) W RE A 05D NNNN 293 (cable diameter size Ø 4.5 - 6mm) W RE A 05D NNNN 308 (cable diameter size Ø 7.5 - 9mm)	without contacts

Ø 1mm machined pins (AWG 24-18)

Insert	Type	Part Number ¹	Contacts
<p>D-Cod.</p>	4way D-coded	W RE A 04D MRAN 283 .. (cable diameter size Ø 9 - 10mm) W RE A 04D MRAN 294 .. (cable diameter size Ø 6 - 8mm) W RE A 04D MRAN 293 .. (cable diameter size Ø 4.5 - 6mm) W RE A 04D MRAN 308 .. (cable diameter size Ø 7.5 - 9mm)	
<p>A-Cod.</p>	5way A-coded	W RE A 05D MRAN 283 .. (cable diameter size Ø 9 - 10mm) W RE A 05D MRAN 294 .. (cable diameter size Ø 6 - 8mm) W RE A 05D MRAN 293 .. (cable diameter size Ø 4.5 - 6mm) W RE A 05D MRAN 308 .. (cable diameter size Ø 7.5 - 9mm)	

Without Contacts (for ordering Ø 0.8mm machined or stamped pins separately)

Insert	Type	Part Number	Contacts
<p>A-Cod.</p>	8way A-coded	W RE A 08D NNNN 283 (cable diameter size Ø 9 - 10mm) W RE A 08D NNNN 294 (cable diameter size Ø 6 - 8mm) W RE A 08D NNNN 293 (cable diameter size Ø 4.5 - 6mm) W RE A 08D NNNN 308 (cable diameter size Ø 7.5 - 9mm)	without contacts

Ø 0.8mm machined pins (AWG 24-20)

Insert	Type	Part Number	Contacts
<p>A-Cod.</p>	8way A-coded	W RE A 08D MRCN 283 (cable diameter size Ø 9 - 10mm) W RE A 08D MRCN 294 (cable diameter size Ø 6 - 8mm) W RE A 08D MRCN 293 (cable diameter size Ø 4.5 - 6mm) W RE A 04D MRCN 308 (cable diameter size Ø 7.5 - 9mm)	

Ø 0.8mm machined pins (AWG 30-22)

Insert	Type	Part Number	Contacts
<p>A-Cod.</p>	8way A-coded	W RE A 08D MRDN 283 (cable diameter size Ø 9 - 10mm) W RE A 08D MRDN 294 (cable diameter size Ø 6 - 8mm) W RE A 08D MRDN 293 (cable diameter size Ø 4.5 - 6mm) W RE A 04D MRDN 308 (cable diameter size Ø 7.5 - 9mm)	

Male Cable Plugs

Angled male cable plug, rotatable backshell - Type RL

90° angled male cable plug with coupling ring, shieldable, variable cable clamps, rotatable backshell. Rotatable connector backshell offers customer-configurable cable outlet direction. The outlet directions can be adjusted in 12 steps of 30° to a maximum angle of 330°.

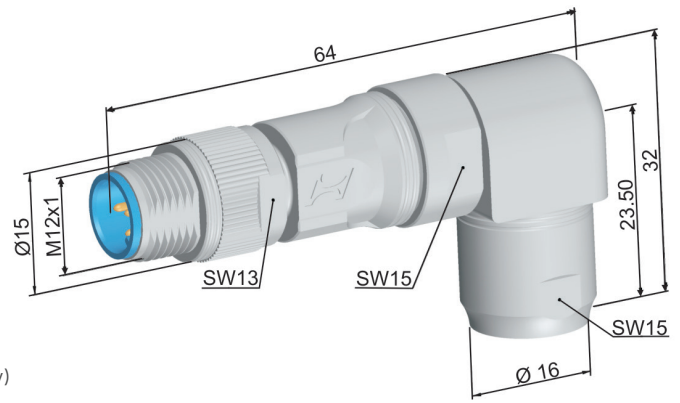

Without Contacts (for ordering Ø 1mm machined or stamped pins separately)

Insert	Type	Part Number	Contacts
<p>D-Cod.</p>	4way D-coded	W RL A 04B NNNN 283 (cable diameter size Ø 9 - 10mm) W RL A 04B NNNN 294 (cable diameter size Ø 6 - 8mm) W RL A 04B NNNN 293 (cable diameter size Ø 4.5 - 6mm) W RL A 04B NNNN 308 (cable diameter size Ø 7.5 - 9mm)	without contacts
<p>A-Cod.</p>	5way A-coded	W RL A 05B NNNN 283 (cable diameter size Ø 9 - 10mm) W RL A 05B NNNN 294 (cable diameter size Ø 6 - 8mm) W RL A 05B NNNN 293 (cable diameter size Ø 4.5 - 6mm) W RL A 05B NNNN 308 (cable diameter size Ø 7.5 - 9mm)	without contacts

Ø 1mm machined pins (AWG 24-18)

Insert	Type	Part Number ¹	Contacts
<p>D-Cod.</p>	4way D-coded	W RL A 04B MRAN 283 .. (cable diameter size Ø 9 - 10mm) W RL A 04B MRAN 294 .. (cable diameter size Ø 6 - 8mm) W RL A 04B MRAN 293 .. (cable diameter size Ø 4.5 - 6mm) W RL A 04B MRAN 308 .. (cable diameter size Ø 7.5 - 9mm)	
<p>A-Cod.</p>	5way A-coded	W RL A 05B MRAN 283 .. (cable diameter size Ø 9 - 10mm) W RL A 05B MRAN 294 .. (cable diameter size Ø 6 - 8mm) W RL A 05B MRAN 293 .. (cable diameter size Ø 4.5 - 6mm) W RL A 05B MRAN 308 .. (cable diameter size Ø 7.5 - 9mm)	

Without Contacts (for ordering Ø 0.8mm machined or stamped pins separately)

Insert	Type	Part Number	Contacts
<p>A-Cod.</p>	8way A-coded	W RL A 08B NNNN 283 (cable diameter size Ø 9 - 10mm) W RL A 08B NNNN 294 (cable diameter size Ø 6 - 8mm) W RL A 08B NNNN 293 (cable diameter size Ø 4.5 - 6mm) W RL A 08B NNNN 308 (cable diameter size Ø 7.5 - 9mm)	without contacts

Ø 0.8mm machined pins (AWG 24-20)

Insert	Type	Part Number	Contacts
<p>A-Cod.</p>	8way A-coded	W RL A 08B MRCN 283 (cable diameter size Ø 9 - 10mm) W RL A 08B MRCN 294 (cable diameter size Ø 6 - 8mm) W RL A 08B MRCN 293 (cable diameter size Ø 4.5 - 6mm) W RL A 08B MRCN 308 (cable diameter size Ø 7.5 - 9mm)	

Ø 0.8mm machined pins (AWG 30-22)

Insert	Type	Part Number	Contacts
<p>A-Cod.</p>	8way A-coded	W RL A 08B MRDN 283 (cable diameter size Ø 9 - 10mm) W RL A 08B MRDN 294 (cable diameter size Ø 6 - 8mm) W RL A 08B MRDN 293 (cable diameter size Ø 4.5 - 6mm) W RL A 08B MRDN 308 (cable diameter size Ø 7.5 - 9mm)	

Male Receptacles

Straight male receptacle - Type EA

Straight male receptacle, front panel mounting M16x1.5

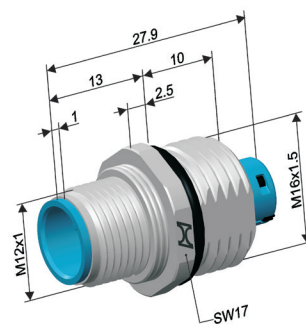

Without Contacts (for ordering Ø 1mm machined or stamped pins separately)

Insert	Type	Part Number	Contacts
<p>D-Cod.</p>	4way D-coded	W EA A 04D NNNN 000	without contacts
<p>A-Cod.</p>	5way A-coded	W EA A 05D NNNN 000	without contacts

Ø 1mm machined pins (AWG 24-18)

Insert	Type	Part Number ¹	Contacts
<p>D-Cod.</p>	4way D-coded	W EA A 04D MRAN 000 ..	
<p>A-Cod.</p>	5way A-coded	W EA A 05D MRAN 000 ..	

Ø 1mm machined pins (solder dip, for pcb assembly, solder pin Ø 1mm)

Insert	Type	Part Number ¹	Contacts
<p>D-Cod.</p>	4way D-coded	W EA A 04D MDAN 000 .. (length X = 8mm) W EA A 04D MDBN 000 .. (length X = 6mm)	
<p>A-Cod.</p>	5way A-coded	W EA A 05D MDAN 000 .. (length X = 8mm) W EA A 05D MDBN 000 .. (length X = 6mm)	

Without Contacts (for ordering Ø 0.8mm machined or stamped pins separately)

Insert	Type	Part Number	Contacts
<p>A-Cod.</p>	8way A-coded	W EA A 08D NNNN 000	without contacts

Ø 0.8mm machined pins

Insert	Type	Part Number	Contacts
<p>A-Cod.</p>	8way A-coded	W EA A 08D MRCN 000 (AWG 24-20) W EA A 08D MRDN 000 (AWG 30-22)	

Male Receptacles

Straight male receptacle - Type EB

Straight male receptacle, rear panel mounting M16x1.5

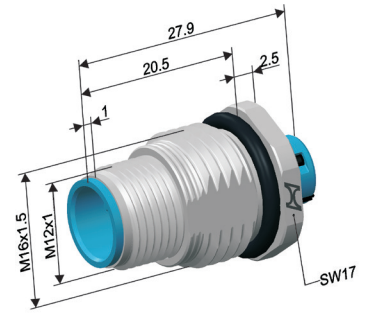

Without Contacts (for ordering Ø 1mm machined or stamped pins separately)

Insert	Type	Part Number	Contacts
<p>D-Cod.</p>	4way D-coded	W EB A 04D NNNN 000	without contacts
<p>A-Cod.</p>	5way A-coded	W EB A 05D NNNN 000	without contacts

Ø 1mm machined pins (AWG 24-18)

Insert	Type	Part Number ¹	Contacts
<p>D-Cod.</p>	4way D-coded	W EB A 04D MRAN 000 ..	
<p>A-Cod.</p>	5way A-coded	W EB A 05D MRAN 000 ..	

Ø 1mm machined pins (solder dip, for pcb assembly, solder pin Ø 1mm)

Insert	Type	Part Number ¹	Contacts
<p>D-Cod.</p>	4way D-coded	W EB A 04D MDAN 000 .. (length X = 8mm) W EB A 04D MDBN 000 .. (length X = 6mm)	
<p>A-Cod.</p>	5way A-coded	W EB A 05D MDAN 000 .. (length X = 8mm) W EB A 05D MDBN 000 .. (length X = 6mm)	

Without Contacts (for ordering Ø 0.8mm machined or stamped pins separately)

Insert	Type	Part Number	Contacts
<p>A-Cod.</p>	8way A-coded	W EB A 08D NNNN 000	without contacts

Ø 0.8mm machined pins

Insert	Type	Part Number	Contacts
<p>A-Cod.</p>	8way A-coded	W EB A 08D MRCN 000 (AWG 24-20) W EB A 08D MRDN 000 (AWG 30-22)	

Male Receptacles

Straight male receptacle - Type ED

Straight male receptacle, front panel mounting M12x1

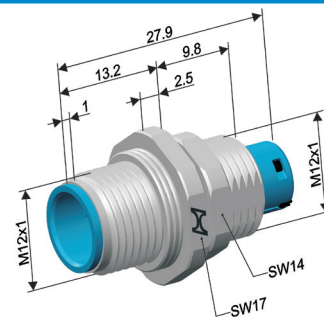

Without Contacts (for ordering Ø 1mm machined or stamped pins separately)

Insert	Type	Part Number	Contacts
<p>D-Cod.</p>	4way D-coded	W ED A 04D NNNN 000	without contacts
<p>A-Cod.</p>	5way A-coded	W ED A 05D NNNN 000	without contacts

Ø 1mm machined pins (AWG 24-18)

Insert	Type	Part Number ¹	Contacts
<p>D-Cod.</p>	4way D-coded	W ED A 04D MRAN 000 ..	
<p>A-Cod.</p>	5way A-coded	W ED A 05D MRAN 000 ..	

Ø 1mm machined pins (solder dip, for pcb assembly, solder pin Ø 1mm)

Insert	Type	Part Number ¹	Contacts
<p>D-Cod.</p>	4way D-coded	W ED A 04D MDAN 000 .. (length X = 8mm) W ED A 04D MDBN 000 .. (length X = 6mm)	
<p>A-Cod.</p>	5way A-coded	W ED A 05D MDAN 000 .. (length X = 8mm) W ED A 05D MDBN 000 .. (length X = 6mm)	

Without Contacts (for ordering Ø 0.8mm machined or stamped pins separately)

Insert	Type	Part Number	Contacts
<p>A-Cod.</p>	8way A-coded	W ED A 08D NNNN 000	without contacts

Ø 0.8mm machined pins

Insert	Type	Part Number	Contacts
<p>A-Cod.</p>	8way A-coded	W ED A 08D MRCN 000 (AWG 24-20) W ED A 08D MRDN 000 (AWG 30-22)	

Male Receptacles

Angled male receptacle - Type EC

90° male receptacle, flange mounting, rotatable back-shell 0° - 330°

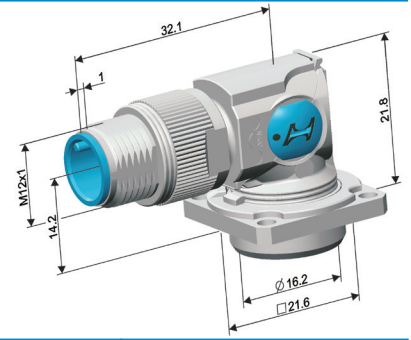

Without Contacts (for ordering Ø 1mm machined or stamped pins separately)

Insert	Type	Part Number	Contacts
<p>D-Cod.</p>	4way D-coded	W EC A 04D NNNN 000	without contacts
<p>A-Cod.</p>	5way A-coded	W EC A 05D NNNN 000	without contacts

Ø 1mm machined pins (AWG 24-18)

Insert	Type	Part Number ¹	Contacts
<p>D-Cod.</p>	4way D-coded	W EC A 04D MRAN 000 ..	
<p>A-Cod.</p>	5way A-coded	W EC A 05D MRAN 000 ..	

Without Contacts (for ordering Ø 0.8mm machined or stamped pins separately)

Insert	Type	Part Number	Contacts
<p>A-Cod.</p>	8way A-coded	W EC A 08D NNNN 000	without contacts

Ø 0.8mm machined sockets

Insert	Type	Part Number	Contacts
<p>A-Cod.</p>	8way A-coded	W EC A 08D MRCN 000 (AWG 24-20) W EC A 08D MRDN 000 (AWG 30-22)	

Female Panel Feed Through

Straight panel feed through - Type DA

Panel feed through, female, hexagon wrench size 17, front panel mounting M16x1.5

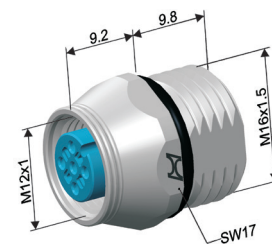

Without Contacts (for ordering Ø 1mm Hypertac® or stamped sockets separately)

Insert	Type	Part Number	Contacts
<p>D-Cod.</p>	4way D-coded	W DA A 04C NNNN 000	without contacts
<p>A-Cod.</p>	5way A-coded	W DA A 05C NNNN 000	without contacts

Ø 1mm Hypertac® sockets (AWG 24-18)

Insert	Type	Part Number ¹	Contacts
<p>D-Cod.</p>	4way D-coded	W DA A 04C FRAN 000 ..	
<p>A-Cod.</p>	5way A-coded	W DA A 05C FRAN 000 ..	

Ø 1mm Hypertac® sockets (solder dip, for pcb assembly, solder pin Ø 1mm)

Insert	Type	Part Number ¹	Contacts
<p>D-Cod.</p>	4way D-coded	W DA A 04C FDAN 000 .. (length X = 8mm) W DA A 04C FDBN 000 .. (length X = 6mm)	
<p>A-Cod.</p>	5way A-coded	W DA A 05C FDAN 000 .. (length X = 8mm) W DA A 05C FDBN 000 .. (length X = 6mm)	

Without Contacts (for ordering Ø 0.8mm Hypertac® or stamped sockets separately)

Insert	Type	Part Number	Contacts
<p>A-Cod.</p>	8way A-coded	W DA A 08C NNNN 000	without contacts

Ø 0.8mm Hypertac® sockets

Insert	Type	Part Number	Contacts
<p>A-Cod.</p>	8way A-coded	W DA A 08C FRCN 000 (AWG 24-20) W DA A 08C FRDN 000 (AWG 30-22)	

Female Panel Feed Through

Straight panel feed through - Type DB

Panel feed through, female, rear panel mounting M16x1.5

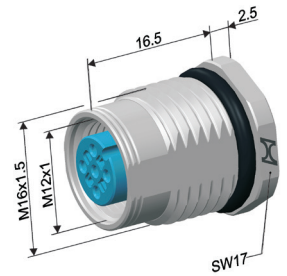

Without Contacts (for ordering Ø 1mm Hypertac® or stamped sockets separately)

Insert	Type	Part Number	Contacts
<p>D-Cod.</p>	4way D-coded	W DB A 04C NNNN 000	without contacts
<p>A-Cod.</p>	5way A-coded	W DB A 05C NNNN 000	without contacts

Ø 1mm Hypertac® sockets (AWG 24-18)

Insert	Type	Part Number ¹	Contacts
<p>D-Cod.</p>	4way D-coded	W DB A 04C FRAN 000 ..	
<p>A-Cod.</p>	5way A-coded	W DB A 05C FRAN 000 ..	

Ø 1mm Hypertac® sockets (solder dip, for pcb assembly, solder pin Ø 1mm)

Insert	Type	Part Number ¹	Contacts
<p>D-Cod.</p>	4way D-coded	W DB A 04C FDAN 000 .. (length X = 8mm) W DB A 04C FDBN 000 .. (length X = 6mm)	
<p>A-Cod.</p>	5way A-coded	W DB A 05C FDAN 000 .. (length X = 8mm) W DB A 05C FDBN 000 .. (length X = 6mm)	

Without Contacts (for ordering Ø 0.8mm Hypertac® or stamped sockets separately)

Insert	Type	Part Number	Contacts
<p>A-Cod.</p>	8way A-coded	W DB A 08C NNNN 000	without contacts

Ø 0.8mm Hypertac® sockets

Insert	Type	Part Number	Contacts
<p>A-Cod.</p>	8way A-coded	W DB A 08C FRCN 000 (AWG 24-20) W DB A 08C FRDN 000 (AWG 30-22)	

Female Panel Feed Through

Straight panel feed through - Type DC

Panel feed through, female, front panel mounting M16x1.5

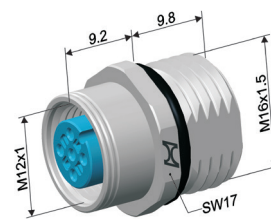

Without Contacts (for ordering Ø 1mm Hypertac® or stamped sockets separately)

Insert	Type	Part Number	Contacts
<p>D-Cod.</p>	4way D-coded	W DC A 04C NNNN 000	without contacts
<p>A-Cod.</p>	5way A-coded	W DC A 05C NNNN 000	without contacts

Ø 1mm Hypertac® sockets (AWG 24-18)

Insert	Type	Part Number ¹	Contacts
<p>D-Cod.</p>	4way D-coded	W DC A 04C FRAN 000 ..	
<p>A-Cod.</p>	5way A-coded	W DC A 05C FRAN 000 ..	

Ø 1mm Hypertac® sockets (solder dip, for pcb assembly, solder pin Ø 1mm)

Insert	Type	Part Number ¹	Contacts
<p>D-Cod.</p>	4way D-coded	W DC A 04C FDAN 000 .. (length X = 8mm) W DC A 04C FDBN 000 .. (length X = 6mm)	
<p>A-Cod.</p>	5way A-coded	W DC A 05C FDAN 000 .. (length X = 8mm) W DC A 05C FDBN 000 .. (length X = 6mm)	

Without Contacts (for ordering Ø 0.8mm Hypertac® or stamped sockets separately)

Insert	Type	Part Number	Contacts
<p>A-Cod.</p>	8way A-coded	W DC A 08C NNNN 000	without contacts

Ø 0.8mm Hypertac® sockets

Insert	Type	Part Number	Contacts
<p>A-Cod.</p>	8way A-coded	W DC A 08C FRCN 000 (AWG 24-20) W DC A 08C FRDN 000 (AWG 30-22)	

Female Panel Feed Through

Straight panel feed through - Type DD

Panel feed through, female, rear panel mounting M16x1.5, with grounding pin

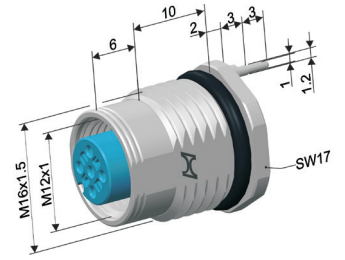

Ø 1mm Hypertac® sockets (solder dip, for pcb assembly, solder pin Ø 1mm)

Insert	Type	Part Number ¹	Contacts
<p>D-Cod.</p>	4way D-coded	<p>W DD A 04C FDAN 000 .. (length X = 8mm)</p> <p>W DD A 04C FDBN 000 .. (length X = 6mm)</p>	
<p>A-Cod.</p>	5way A-coded	<p>W DD A 05C FDAN 000 .. (length X = 8mm)</p> <p>W DD A 05C FDBN 000 .. (length X = 6mm)</p>	

Female Panel Feed Through

Straight panel feed through - Type DE

Panel feed through, female, front panel mounting M12x1

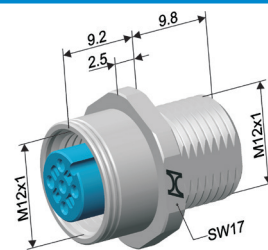

Without Contacts (for ordering Ø 1mm Hypertac® or stamped sockets separately)

Insert	Type	Part Number	Contacts
	4way D-coded	W DE A 04C NNNN 000	without contacts
	5way A-coded	W DE A 05C NNNN 000	without contacts

Ø 1mm Hypertac® sockets (AWG 24-18)

Insert	Type	Part Number ¹	Contacts
	4way D-coded	W DE A 04C FRAN 000 ..	
	5way A-coded	W DE A 05C FRAN 000 ..	

Ø 1mm Hypertac® sockets (solder dip, for pcb assembly, solder pin Ø 1mm)

Insert	Type	Part Number ¹	Contacts
	4way D-coded	W DE A 04C FDAN 000 .. (length X = 8mm) W DE A 04C FDBN 000 .. (length X = 6mm)	
	5way A-coded	W DE A 05C FDAN 000 .. (length X = 8mm) W DE A 05C FDBN 000 .. (length X = 6mm)	

Without Contacts (for ordering Ø 0.8mm Hypertac® or stamped sockets separately)

Insert	Type	Part Number	Contacts
	8way A-coded	W DE A 08C NNNN 000	without contacts

Ø 0.8mm Hypertac® sockets

Insert	Type	Part Number	Contacts
	8way A-coded	W DE A 08C FRCN 000 (AWG 24-20) W DE A 08C FRDN 000 (AWG 30-22)	

Applications

Rolling Stock



- Driver Cabin
- Lightning
- Alarms
- Sensors
- Electromagnetic Valves

Signalling

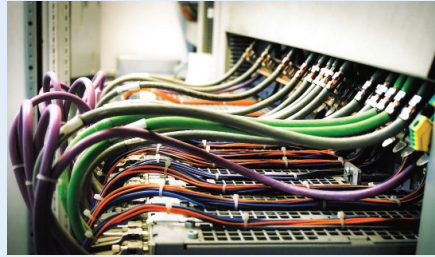

- Digital Tracking
- Communication-based Train Control
- Passenger Information Systems
- Passenger Entertainment

Rail Infrastructure



- Video Surveillance
- Ticketing Machines
- Electronic Displays

Machinery



- Processing Equipment
- Manufacturing Machine Tools
- Production Test Equipment
- Bespoke OEM Production Equipment

Factory Automation

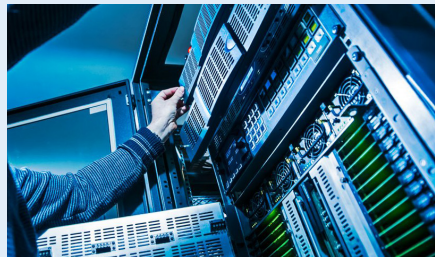

- Control Equipment
- Network Components
- Sensors and Actuators
- Servomotors and Drives
- Inverters

Test Equipment

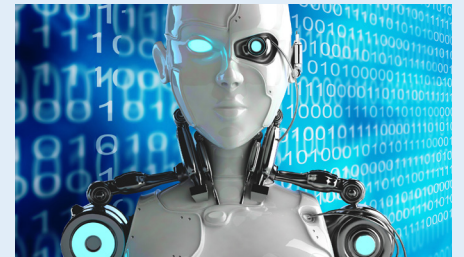

- Test Bench
- Encoders
- Simulators
- Probers

Contacts

Hypertac® hyperboloid sockets

Hypertac® Ø 1 mm crimp contacts

Type	Termination Cross Section	Part Number	Ordering	Part Number Crimping Tool	Layout
Hyperboloid socket	AWG 24-18 0.24-1.0 mm ²	020.001022.1020	FRAN	B151 + B200	
Hyperboloid socket	AWG 30-22 0.05-0.34 mm ²	020.000353.1020	FRBN	B150 + B055/A	
Pin	AWG 24-18 0.24-1.0 mm ²	021.001039.1020	MRAN	B151 + B200	
Pin	AWG 30-22 0.05-0.34 mm ²	021.000402.1020	MRBN	B150 + B055/A	

Hypertac® Ø 0.8 mm crimp contacts

Type	Termination Cross Section	Part Number	Ordering	Part Number Crimping Tool	Layout
Hyperboloid socket	AWG 24-20 0.24-0.5 mm ²	020.001024.1020	FRCN	B151 + B200	
Hyperboloid socket	AWG 30-22 0.05-0.34 mm ²	020.001027.1020	FRDN	B150 + B395	
Pin	AWG 24-20 0.24-0.5 mm ²	021.001044.1020	MRCN	B151 + B200	
Pin	AWG 30-22 0.05-0.34 mm ²	021.001045.1020	MRDN	B150 + B395	







Hypertac® Ø 1 mm with straight solder pin

Type	Solder pin lengths x	Part Number	Ordering	Solder Pin Ø	Layout
Hyperboloid socket	solder pin 8 mm	090.000029.2000	FDAN	1 mm	
Hyperboloid socket	solder pin 6 mm	090.000030.2000	FDBN	1 mm	
Pin	solder pin 8 mm	070.000011.2000	MDAN	1 mm	
Pin	solder pin 6 mm	070.000012.2000	MDBN	1 mm	







Contacts

Stamped hyperboloid crimp contacts HCS™

HCS™ Ø 1mm stamped crimp contacts





Type	Termination Cross Section	Part Number Reel 9,000 pcs.	Part Number Reel 300 pcs.	Part Number Crimping Tool	Layout
Hyperboloid socket	AWG 32-28 0.03-0.08 mm ²	020.000376.2000	020.000376.2000.A2	B287/32 - 28	
Hyperboloid socket	AWG 28-24 0.08-0.2 mm ²	020.000377.2000	020.000377.2000.A2	B287/28 - 24	
Hyperboloid socket	AWG 24-20 0.2-0.5 mm ²	020.000378.2000	020.000378.2000.A2	B287/24 - 20	
Round pin	AWG 32-28 0.03-0.08 mm ²	021.001005.1025	021.001005.1025.A2	B287/32 - 28	
Round pin	AWG 28-24 0.08-0.2 mm ²	021.001006.1025	021.001006.1025.A2	B287/28 - 24	
Round pin	AWG 24-20 0.2-0.5 mm ²	021.001007.1025	021.001007.1025.A2	B287/24 - 20	

HCS™ Ø 0.8mm stamped crimp contacts

Type	Termination Cross Section	Part Number Reel 9,000 pcs.	Part Number Reel 300 pcs.	Part Number Crimping Tool	Layout
Hyperboloid socket	AWG 32-28 0.03-0.08 mm ²	020.001018.2000	020.001018.2000.A2	B287/32-28	
Hyperboloid socket	AWG 28-24 0.08-0.2 mm ²	020.001019.2000	020.001019.2000.A2	B287/28-24	
Hyperboloid socket	AWG 24-20 0.2-0.5 mm ²	020.001020.2000	020.001020.2000.A2	B287/24-20	
Round pin	AWG 32-28 0.03-0.08 mm ²	021.001035.1025	021.001035.1025.A2	B287/32-28	
Round pin	AWG 28-24 0.08-0.2 mm ²	021.001036.1025	021.001036.1025.A2	B287/28-24	
Round pin	AWG 24-20 0.2-0.5 mm ²	021.001037.1025	021.001037.1025.A2	B287/24-20	

Tools

Crimping tools for Hypertac® contacts

Type	Part Number	
Hand crimping tool	B151	
Positioner	B200	
Hand crimping tool	B150	
Positioner	B055/A (Ø 1mm contacts)	
	B395 (Ø 0.8mm contacts)	

Crimping tools for stamped contacts

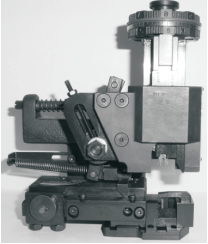
Type	Part Number	Termination Cross Section	
Hand crimping tools with feeder line for 300 pcs. reels	B287/32 - 28	0.03 - 0.08mm ² (AWG 32-28)	
	B287/28 - 24	0.08 - 0.2mm ² (AWG 28-24)	
	B287/24 - 20	0.2 - 0.5mm ² (AWG 24-20)	
Applicators for crimping machines with feeder line AMP/Schäfer ESP 100	B288/32 - 28	0.03 - 0.08mm ² (AWG 32-28)	
	B288/28 - 24	0.08 - 0.2mm ² (AWG 28-24)	
	B288/24 - 20	0.2 - 0.5mm ² (AWG 24-20)	

Additional Services & Accessoires

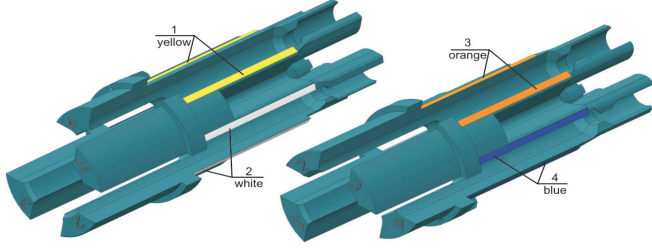
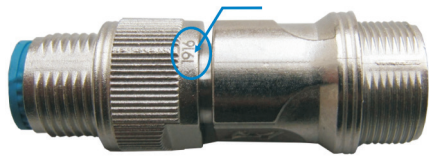

Additional Services (please contact factory for individual order code)

Type	Available	
Color coded contact support	on request	
Coupling nut marked with calendar week and year (CWYY)	Straight cable plug Type RC WRCA 04 / 05 / 08 on request	

Cable clamps

Type	Part Number	
For cable plugs	.293 ø 4.5 - 6mm	
	.294 ø 6 - 8mm	
	.283 ø 9 - 10mm	
	.308 ø 7.5 - 9mm	

Accessoires

Type	Part Number	
Protection caps	031.294.1000 (for solder pins)	
	031.001087.1000 (for external threads)	
Dust shield caps	C/BEL/9 (for male cable plugs)	
	007.001182.1002 (for female cable plugs)	

Assembly instruction

Straight female cable plug Type PC, PJ

Stripping Length		
	Hypertac® contacts	Stamped Contacts
x	4mm	3mm
A	23mm	

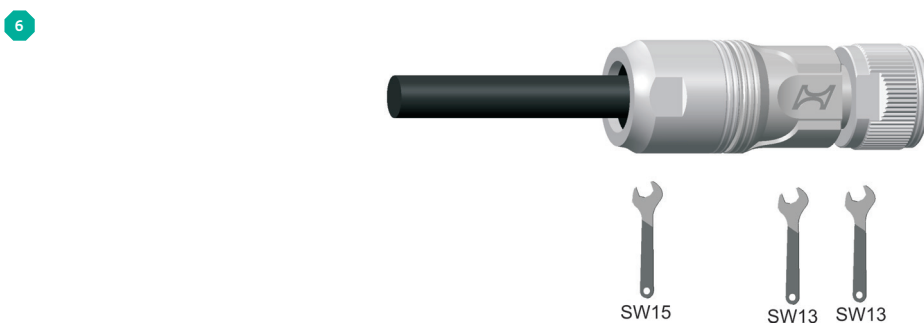
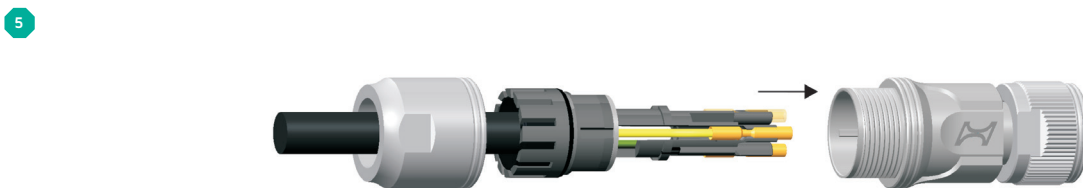
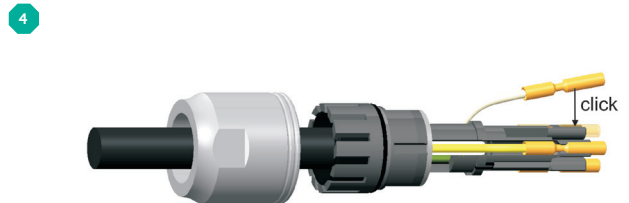
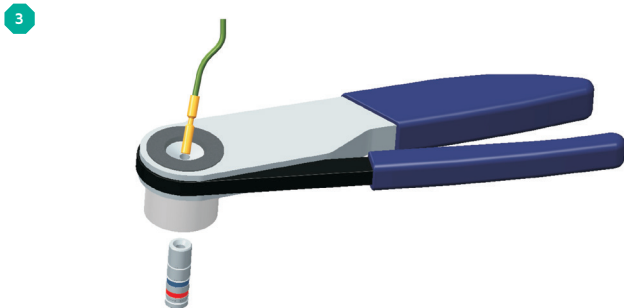
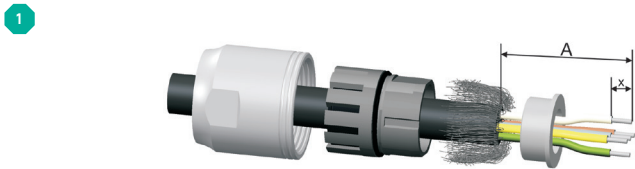
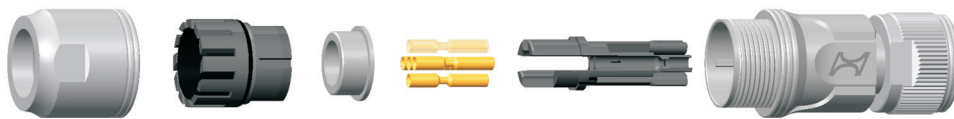

Assembly instruction

Angled female cable plug Type PE

Stripping Length		
	Hypertac® contacts	Stamped Contacts
x	3mm	4mm
A	35mm	

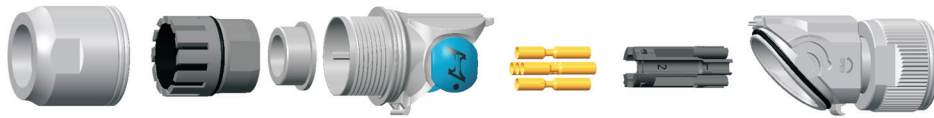

- 1
- 2
- 3
- 4
- 5
- 6
- 7
- 8

Assembly instruction

Angled male and female cable plug with rotatable backshell Type PL, RL

Stripping Length	
	Machined contacts
x	4mm
A	~ 20-25mm

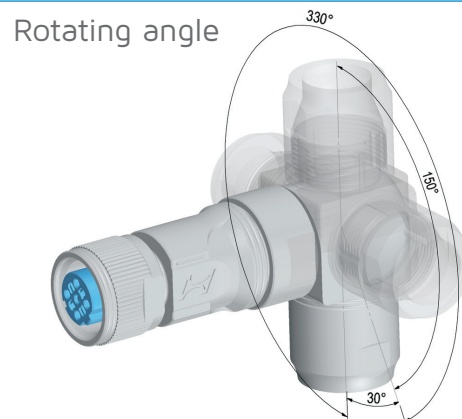
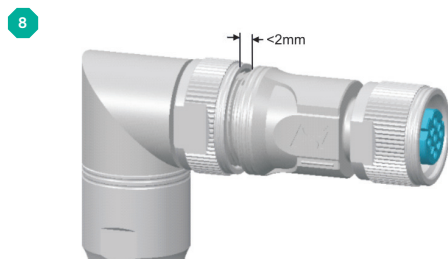
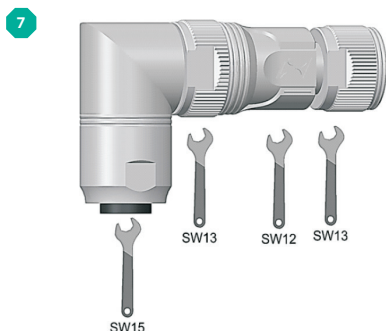
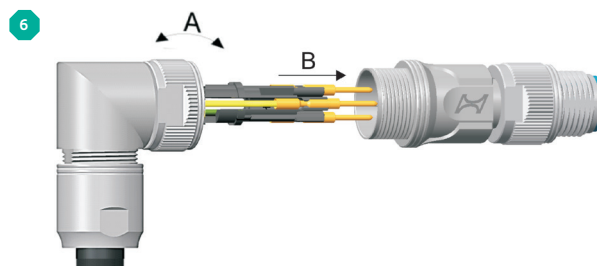
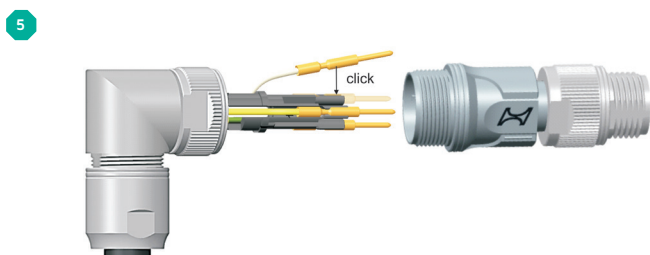
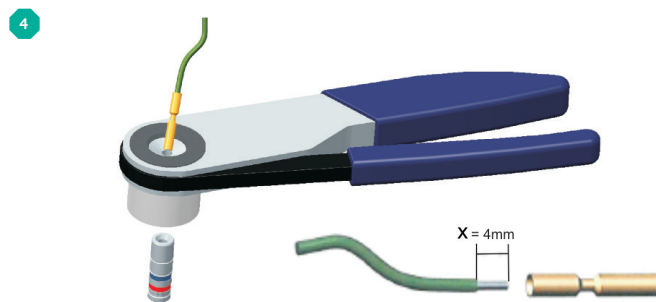
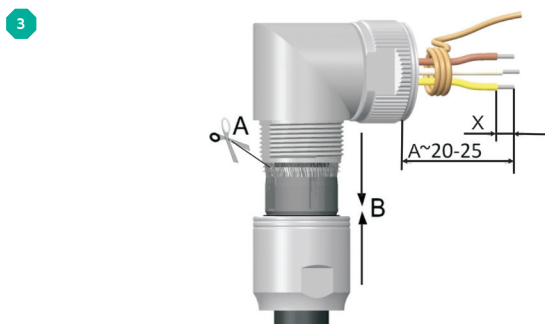
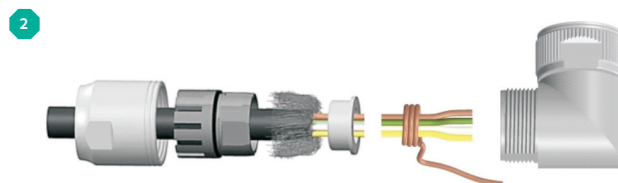
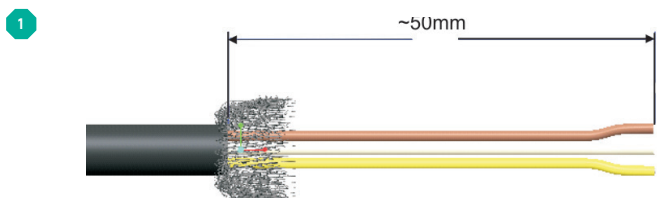

Assembly instruction

Straight male cable plug Type RC, RJ

Stripping Length

	Machined contacts	Stamped Contacts
x	4mm	3mm
A	23mm	

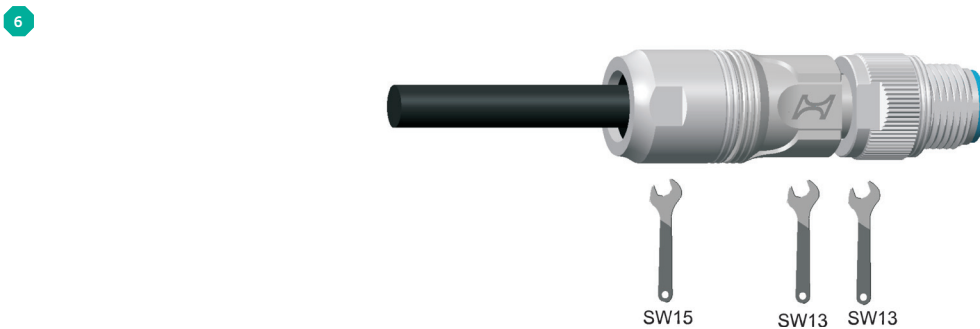
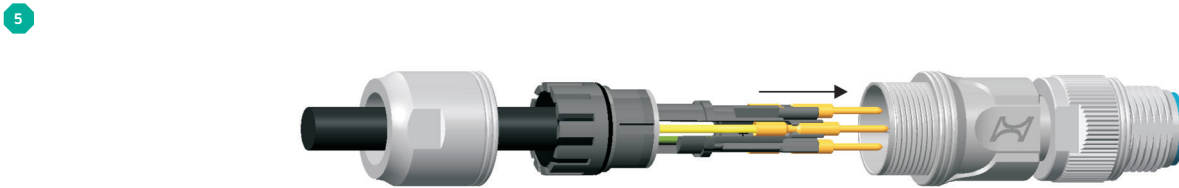
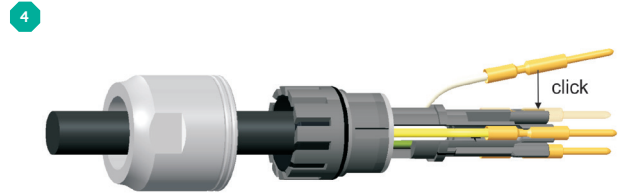
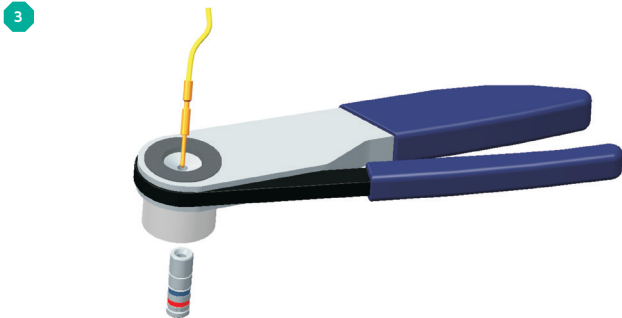
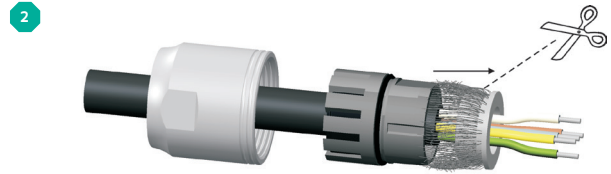
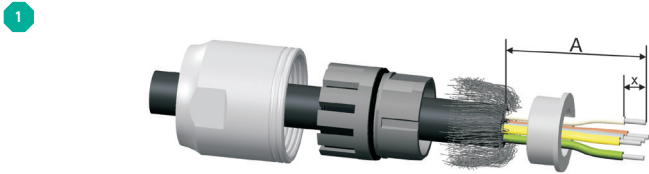
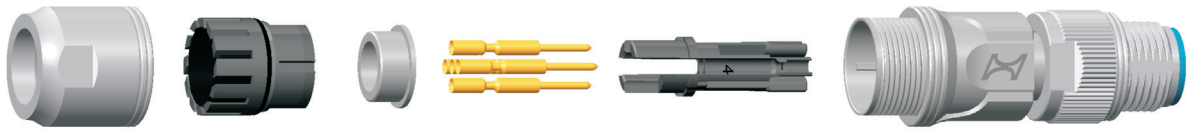

Assembly instruction

Angled male cable plug Type RE

Stripping Length		
	Machined contacts	Stamped Contacts
x	4mm	3mm
A	35mm	

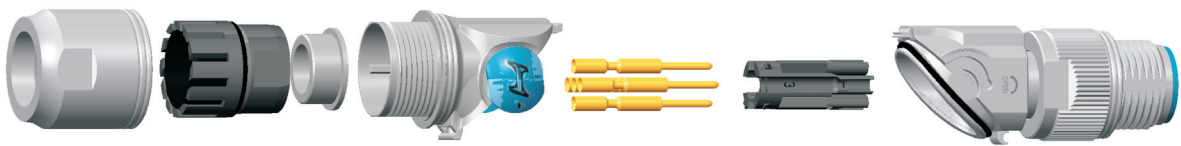

- 1
- 2
- 3
- 4
- 5
- 6
- 7
- 8

Assembly instruction

Straight male receptacle Type EA, EB, ED

Stripping Length		
	Machined contacts	Stamped Contacts
x	4mm	3mm

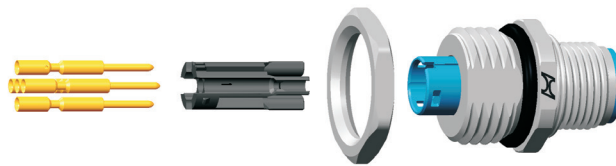

1

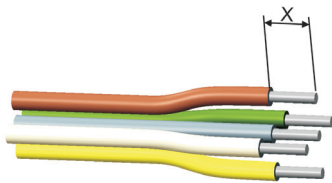

2



3

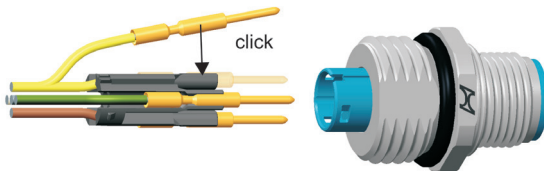

4

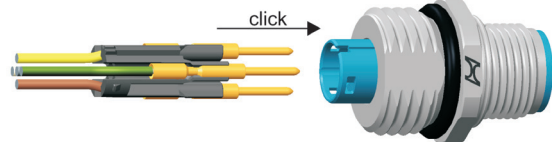

5

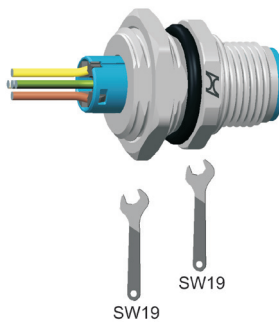

Mounting arrangement for straight receptacle and panel feed trough

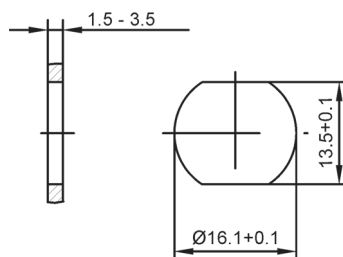

Assembly instruction

Angled male receptacle Type EC

Stripping Length

	Machined contacts	Stamped Contacts
x	4mm	3mm



1

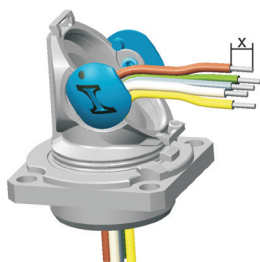

2

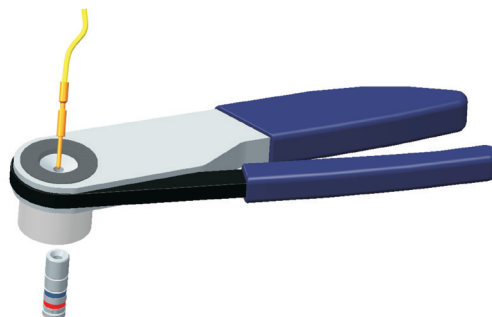

3

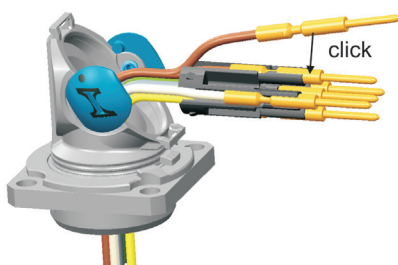

4

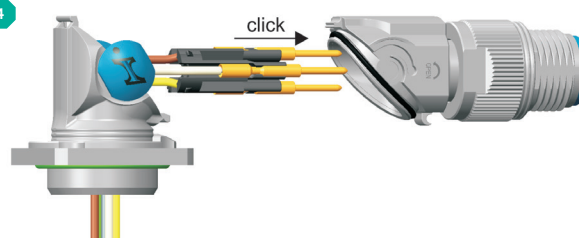

5

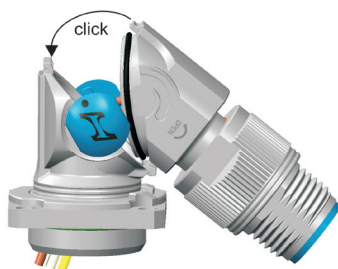

6

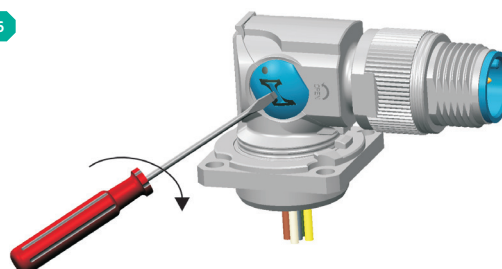

7

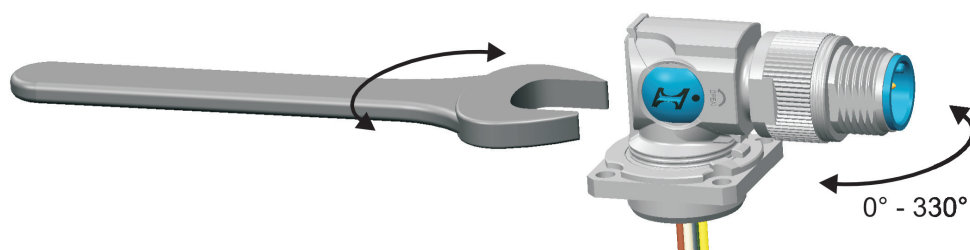

Assembly instruction

Female panel feed through Type DA, DB, DC, DD, DE

Stripping Length		
	Hypertac® contacts	Stamped Contacts
x	4mm	3mm

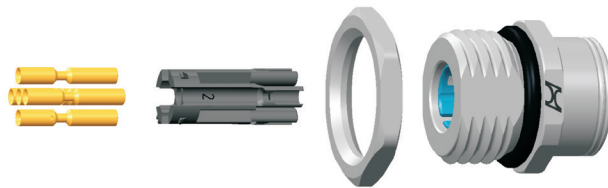

1

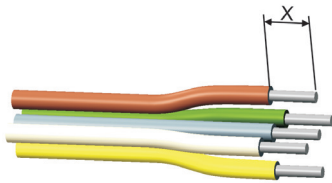

2

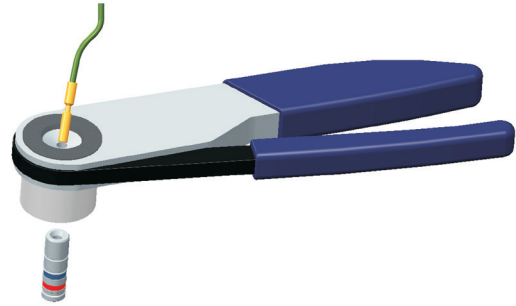

3

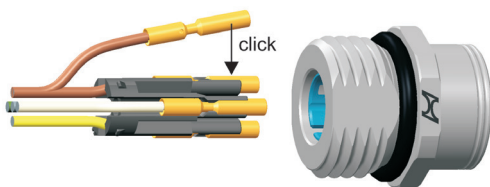

4

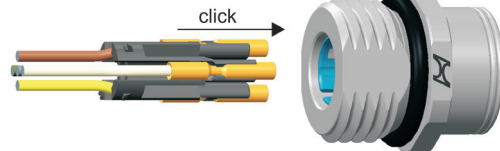

5

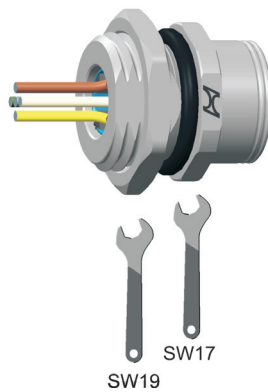

Disclaimer 2017

All of the information included in this catalogue is believed to be accurate at the time of printing. It is recommended, however, that users should independently evaluate the suitability of each product for their intended application and be sure that each product is properly installed, used and maintained to achieve desired results.

Smiths Interconnect makes no warranties as to the accuracy or completeness of the information, and disclaims any liability regarding its use.

Smiths Interconnect reserves the right to modify design and specifications, in order to improve quality, keep pace with technological development or meet specific production requirements.

No reproduction or use without express permission of editorial and pictorial content, in any manner.

Product Portfolio

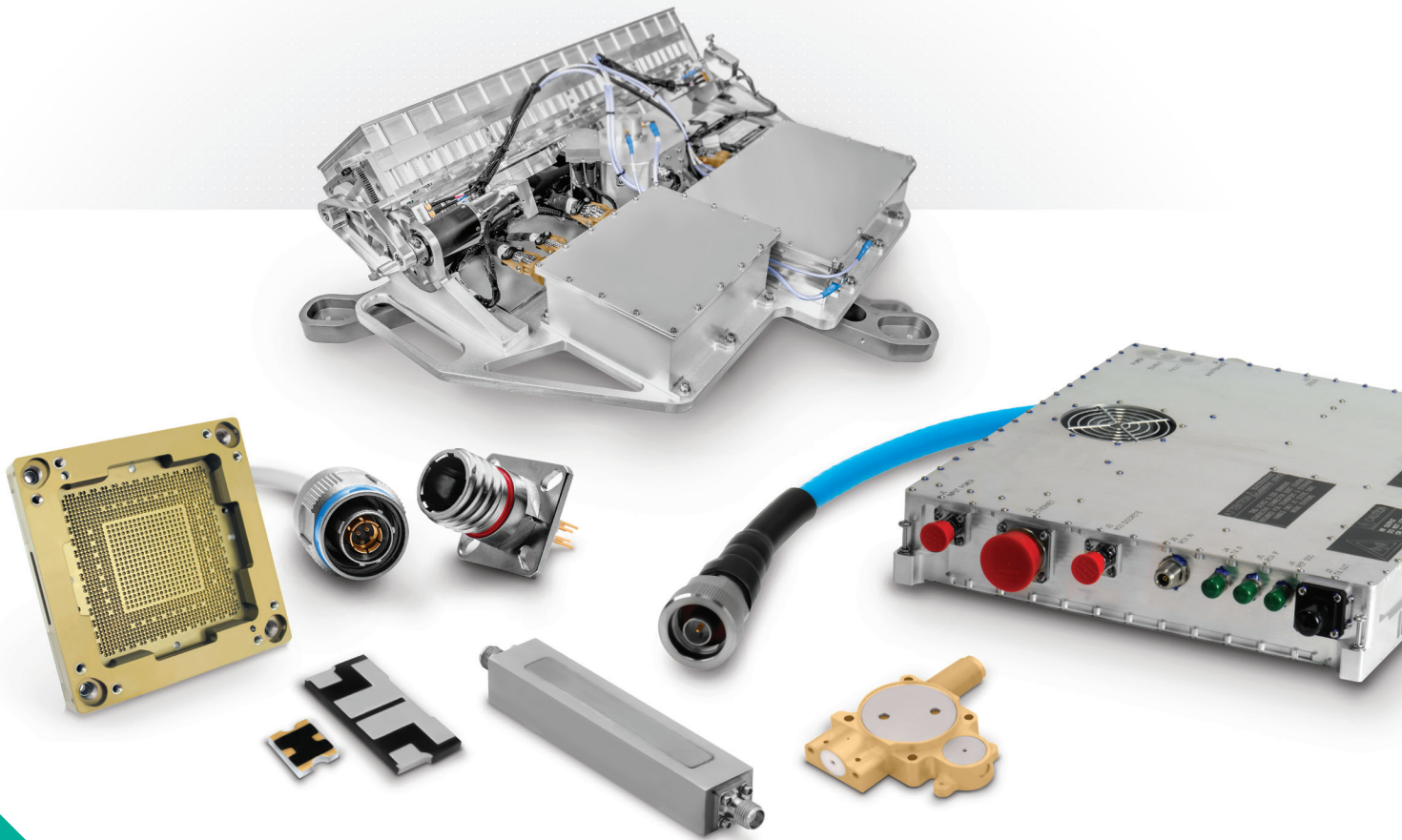

- Antenna Systems
 - Cable Assemblies
 - Connector Solutions
 - Ferrite Components & Assemblies
 - RF Filter Components & Assemblies
 - Integrated Microwave Assemblies
 - Millimeter-Wave Solutions
 - RF Components
 - Test Sockets and WLCSP Probe Heads
 - Time & Frequency Systems

Global Support

UK Headquarters

- London, UK
+44 20 7004 1600
info.uk@smithsinterconnect.com

US Headquarters

- Stuart, FL
+1 772 286 9300
info.us@smithsinterconnect.com

Americas

- Costa Mesa, CA
+1 714 371 1100
info.us@smithsinterconnect.com
- Milpitas, CA
+1 408 957 9607 x 1125
info.us@smithsinterconnect.com
- Stuart, FL
+1 772 286 9300
info.us@smithsinterconnect.com
- Hudson, MA
+1 978 568 0451
info.us@smithsinterconnect.com
- Northampton, MA
+1 413 582 9620
info.northampton@smithsinterconnectinc.com
- Tampa, FL
+ 1 813 901 7200
info.tampa@smithsinterconnectinc.com
- Kansas City, KS
+1 913 342 5544
info.us@smithsinterconnect.com
- Salisbury, MD
+1 800 780 2169
info.us@smithsinterconnect.com
- Thousand Oaks, CA
+1 805 267 0100
info.thousandoaks@smithsinterconnectinc.com

Europe

- Deggendorf, Germany
+49 991 250 120
info.de@smithsinterconnect.com
- Genova, Italy
+39 0 10 60361
info.it@smithsinterconnect.com
- Dundee, UK
+44 1382 427 200
info.dundee@smithsinterconnect.com
- Rouen, France
+33 2 32 96 91 76
info.fr@smithsinterconnect.com
- Elstree, UK
+44 20 8236 2400
info.uk@smithsinterconnect.com

Asia

- Shanghai, China
+86 21 3318 4650
info.asia@smithsinterconnect.com
- Suzhou, China
+86 512 6273 1188
info.asia@smithsinterconnect.com
- Singapore
+65 6846 1655
info.asia@smithsinterconnect.com

more > smithsinterconnect.com | [in](#) [t](#) [G+](#) [v](#)