

Buccaneer 400 Series Environmentally Sealed Connector

SPECIFICATION

Electrical:

Poles:	2, 3	4, 6, 8	10, 12
Current Rating:	8A	5A	1A
Voltage Rating:	250V	125V	50V
Contact Resistance:	<5mΩ		
Insulation Resistance:	>10 ⁶ MΩ (@ 500V a.c.)		
AC Breakdown Voltage:	2.5kV		
Operating Temperature Range:	-40° to +80°C		
Approvals:	UL, CSA & VDE		

Mechanical:

Sealing:	IP68, EN 60529						
Cable Acceptance:	3.0 - 7.0mm						
Contact Accommodation:	2, 3 pole, 20 - 24 AWG 4, 6, 8 pole, 22 - 26 AWG 10, 12 pole, 24 - 28 AWG						
Termination:	Crimp, solder and PCB						
Insertion/Withdrawal Force:							
No. poles:	2	3	4	6	8	10	12
Insertion Force (typ):	19N	25N	27N	27N	28N	55N	62N
Withdrawal Force (typ):	12N	17N	17N	21N	22N	25N	29N
Cable Retention force:	80N						

Dimensions:

Overall dimensions of connectors when mated together	
Flex + Flex In-Line	80mm
Dia. over coupling ring	19.1mm

Material:

Body Mouldings:	Polyamide
Flammibility Rating:	UL94V-0
UV Resistance:	To EN 50021:1999
Contacts:	Copper alloy, Gold plated
O Rings:	Nitrile
Chassis Sealing O Ring:	Nitrile
RoHS	Compliant

Caution: Not for interrupting current
Attention: Ne pas utiliser pour couper le courant

IMPORTANT SAFETY NOTICE

For your protection all mains (250V) equipment used out of doors, in damp or wet conditions should be supplied from a correctly fused source and protected by an approved R.C.D. to BS7071, BS7288, BS4293, BS EN 61008-1, BS EN 1008-2-2

IF IN DOUBT SEEK ADVICE

Mains Wire Connections

Important: connect wires
Brown to terminal L
Blue to terminal N
Green/Yellow to terminal E

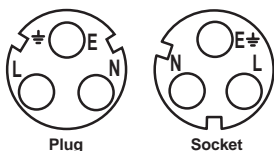

400 Series Buccaneer

IP68 Sealed Electrical Cable Connectors

Wiring and Assembly Instructions

B BULGIN

www.bulgin.co.uk

Buccaneer 400 Series Environmentally Sealed Connectors

IMPORTANT - PLEASE READ INSTRUCTIONS PRIOR TO ASSEMBLY

Before using the connector, it is important that these instructions are carefully read and understood to ensure the connector system is completely water tight and electrically safe. IF IN DOUBT PLEASE CONSULT A QUALIFIED ELECTRICIAN.

Body Moulding

The body moulding is a snap fit assembly. This is a once only fit to be completed after the connector has been wired. **Do not snap on before wiring is complete.**

Cable Glands

To ensure the correct cable sealing pairs of cable glands and collets are available to accurately fit cable diameters from 3.0 up to 7.0mm in 0.5mm steps. It is important to match the correct gland and collet to the cable used, these are:

Cable diameter	Gland/Collet Colour	Cable diameter	Gland/Collet Colour
3.0-3.5mm	Light Grey	5.0-5.5mm	Yellow
3.5-4.0mm	Grey	5.5-6.0mm	Blue
4.0-4.5mm	Green	6.0-6.5mm	White
4.5-5.0mm	Red	6.5-7.0mm	Black

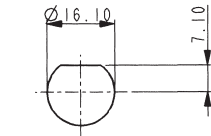

Panel cut out details for PX0412

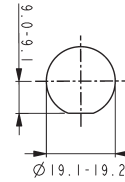

Panel cut out details for PX0413

ASSEMBLY/WIRING INSTRUCTIONS

1. Thread the Clamp Nut, Collet, Gland and Body Moulding on to the cable. Also thread on the sealing cap retaining straps if using sealing caps with the flex connectors.

Note: When using Flex Connector PX0410, also check the locking ring is fitted over the Carrier Housing (this is a one piece moulding on the In-line Flex Connector PX0411).

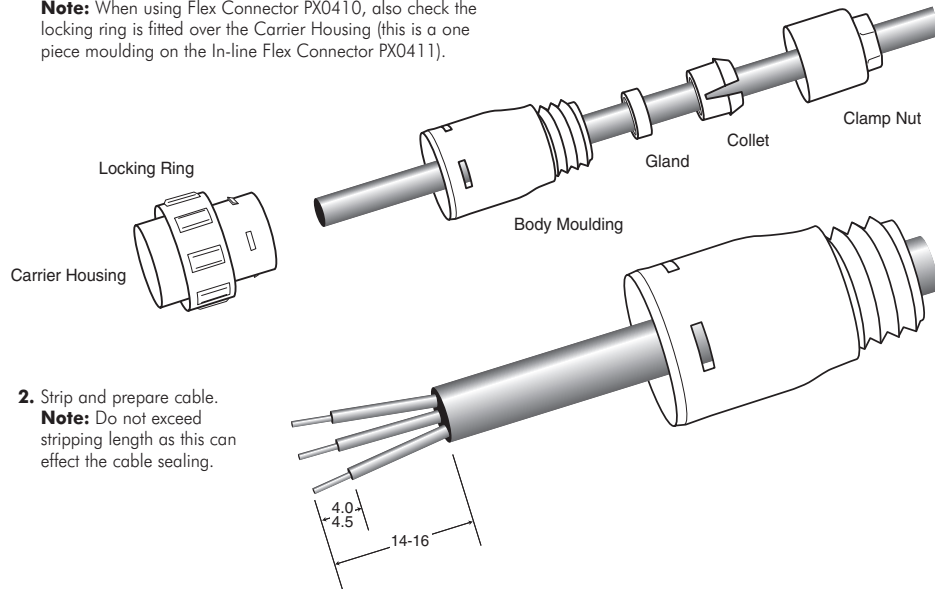

2. Strip and prepare cable.
Note: Do not exceed stripping length as this can effect the cable sealing.

3. Insert bared wire end into contacts, crimp or solder to secure wire.
Note: When using crimp contacts ensure correct positioner is used in the crimp tool.

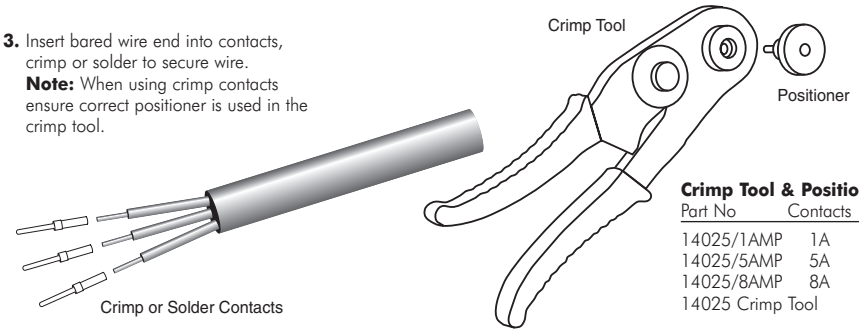

Crimp Tool & Positioners

Part No	Contacts	Colour
14025/1AMP	1A	Green
14025/5AMP	5A	Red
14025/8AMP	8A	Blue
14025	Crimp Tool	

4. Assemble contacts in to the Carrier Housing ensuring they are in the correct location and pushed fully home. A contact insertion/extraction tool is available:
Part No 13027 - 1 amp
Part No 13027/1 - 5 amp
Part No 13027/2 - 8 amp

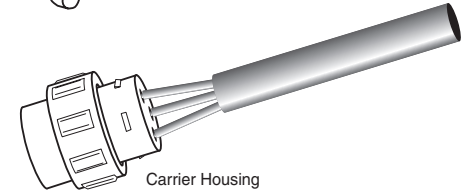

Pin identification:

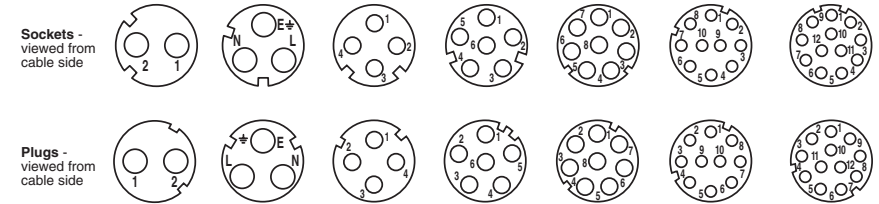

5. Check the internal O Ring is in place and correctly seated. Bring the Body Moulding down the cable and snap firmly over the carrier moulding ensuring that the steps on the blue Carrier Housing are aligned with the apertures in the Body Moulding and that the sealing cap strap is not over the blue Carrier Housing.

Note: once the Body Moulding is snapped over it cannot be removed.

6. Bring the Gland and Collet down the cable and locate in the Body Moulding. Screw the Clamp Nut onto the body moulding and tighten as close to the shoulder as possible.
If the Sealing Cap Assembly is being used, slide over the Body Assembly and locate over the shoulder of the Body Moulding.

